

FEATURES

Low forward voltage
Fast reverse recovery time

SOT-23

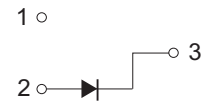
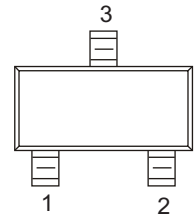

Maximum Ratings @Ta=25°C

Parameter	Symbol	Limit	Unit
Non-Repetitive Peak Reverse Voltage	V_{RM}	85	V
DC Blocking Voltage	V_R	80	V
Forward Continuous Current	I_{FM}	300	mA
Average Rectified Output Current	I_O	100	mA
Non-Repetitive Peak Forward Surge Current @t=8.3ms	I_{FSM}	2.0	A
Power Dissipation	P_D	150	mW
Thermal Resistance from Junction to Ambient	$R_{\theta JA}$	833	°C/W
Junction Temperature	T_J	150	°C
Storage Temperature Range	T_{STG}	-55~+150	°C

Electrical Characteristics @Ta=25°C

Parameter	Symbol	Min	Typ	Max	Unit	Conditions
Reverse breakdown voltage	$V_{(BR)}$	80			V	$I_R=100\mu A$
Forward voltage	V_{F1}		0.60		V	$I_F=1mA$
	V_{F2}		0.72		V	$I_F=10mA$
	V_{F3}		0.90	1.2	V	$I_F=100mA$
Reverse current	I_{R1}			0.1	uA	$V_R=30V$
	I_{R2}			0.5	uA	$V_R=80V$
Capacitance between terminals	C_T		0.9	3.0	pF	$V_R=0, f=1MHz$
Reverse recovery time	t_{rr}		1.6	4.0	ns	$I_F=I_R=10mA, I_{rr}=0.1 \times I_R$



Typical Characteristics

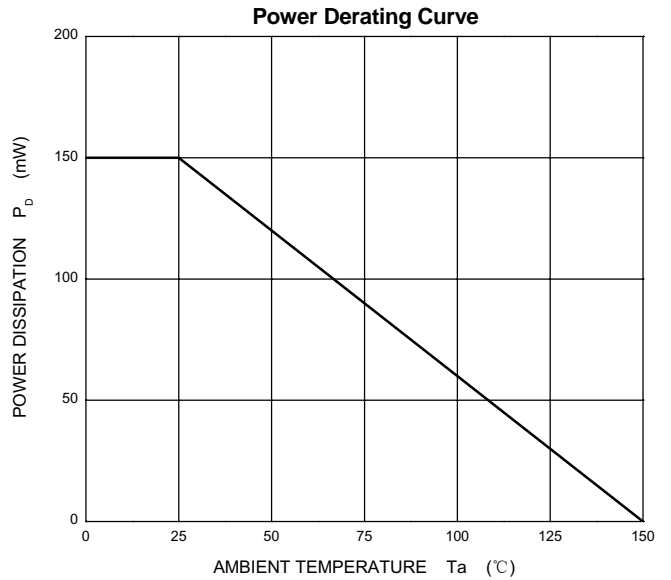
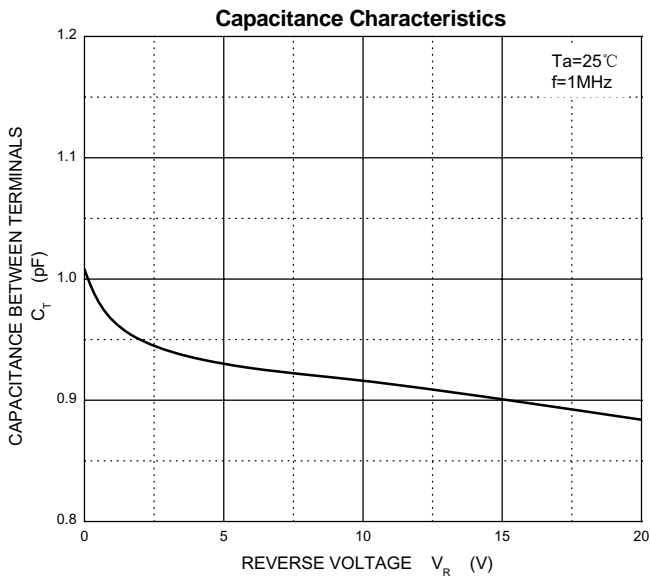
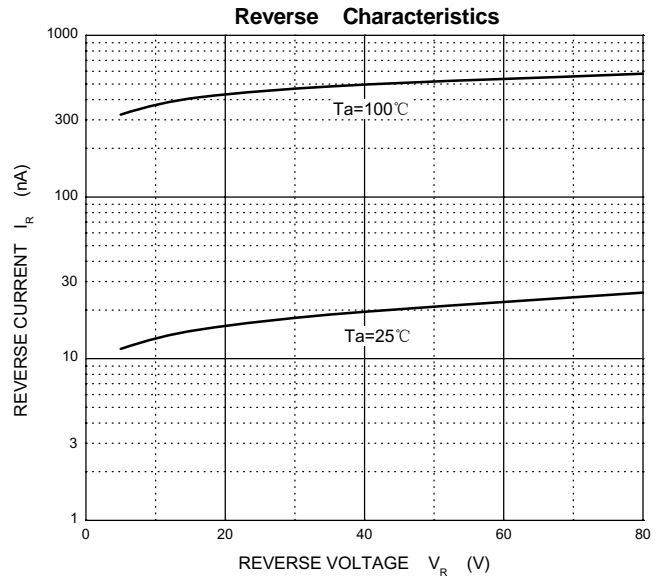
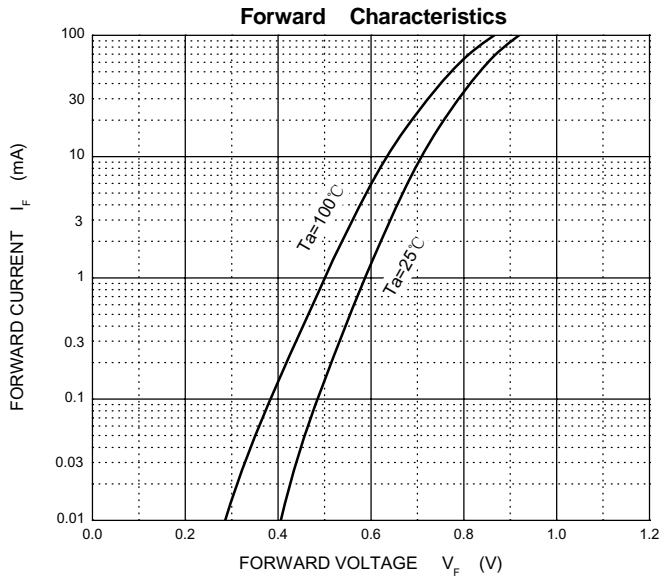



SOT-23 Package Outline Dimensions

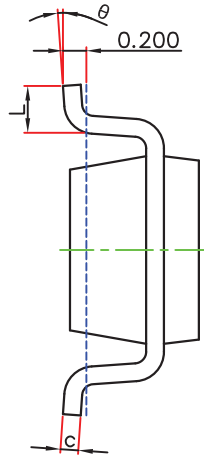
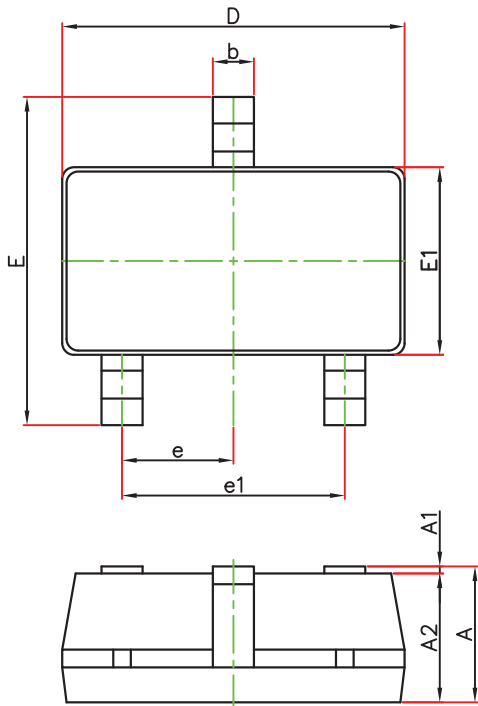

Symbol	Dimensions In Millimeters		Dimensions In Inches	
	Min.	Max.	Min.	Max.
A	1.050	1.250	0.041	0.049
A1	0.000	0.100	0.000	0.004
A2	1.050	1.150	0.041	0.045
b	0.300	0.500	0.012	0.020
c	0.100	0.200	0.004	0.008
D	2.820	3.020	0.111	0.119
E1	1.500	1.700	0.059	0.067
E	2.650	2.950	0.104	0.116
e	0.950(BSC)		0.037(BSC)	
e1	1.800	2.000	0.071	0.079
L	0.300	0.600	0.012	0.024
θ	0°	8°	0°	8°

SOT-23 Suggested Pad Layout

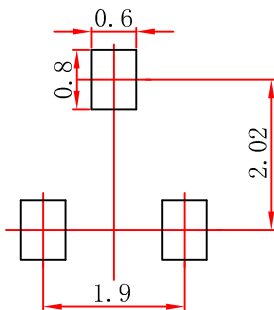

- Note:
1. Controlling dimension: in millimeters.
 2. General tolerance: ± 0.05mm.
 3. The pad layout is for reference purposes only.

SOT-23 Tape and Reel

SOT-23 Embossed Carrier Tape

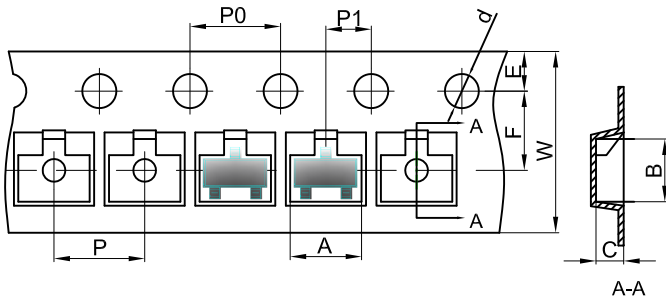

Packaging Description:

SOT-23 parts are shipped in tape. The carrier tape is made from a dissipative (carbon filled) polycarbonate resin. The cover tape is a multilayer film (Heat Activated Adhesive in nature) primarily composed of polyester film, adhesive layer, sealant, and anti-static sprayed agent. These reeled parts in standard option are shipped with 3,000 units per 7" or 17.8cm diameter reel. The reels are clear in color and is made of polystyrene plastic (anti-static coated).

Dimensions are in millimeter										
Pkg type	A	B	C	d	E	F	P0	P	P1	W
SOT-23	3.15	2.77	1.22	Ø1.50	1.75	3.50	4.00	4.00	2.00	8.00

SOT-23 Tape Leader and Trailer

